



# BKtel

## FTTH-Solutions

High Performance  
Fiber-to-the-Home Networks



BKtel develops and manufactures leading edge active and passive equipment for FTTH and HFC broadband networks. Our products meet the various requirements for modular and flexible solutions in fiber optic network design, enabling high performance data, telephony, and TV services. With Research & Development and Production based in Germany and more than 18 years of experience, BKtel is a partner you can rely on.

# Connecting the World at the Speed of Light



## Fiber-to-the-Home: The Ultimate Solution

An all-fiber network up to the subscriber is the ultimate solution for broadband connectivity because it provides virtual unlimited bandwidth and enables simultaneous delivery of multiple services. It plays the key role in next generation access networks. Realized in a point-to-point architecture fiber shows its advantages for broadband bidirectional services such as data and telephony. Regarding TV services, the RF Video Overlay in point-to-multipoint architecture is the answer for a technological mature, cost efficient and reliable solution, with the plus of a high subscriber acceptance.

## BKtel Products

Based on this philosophy - point-to-point optical Ethernet and RF Video Overlay - BKtel has developed a comprehensive product portfolio. Next to the optical transmitters, optical amplifiers and passive optical components such as splitters and WDM filters for RF Video Overlay BKtel offers a series of customer premises equipment units. The equipment is designed with a future save system concept and a unified management. Interoperability with all major metro access switches present in the market, demonstrated in several projects, show seamless integration in turnkey FTTH systems. Complete management solution including autoprovisioning and remote firmware upgrade is available.

## Multigigabit FTTH: EPtP with up to 2.5 Gbps

BKtel's FTTH CPE concept is based on a clear separation of the optical network termination device and the Residential Home Gateway (RHG). Depending on the individual provider's demand a preselected RHG or a subscriber chosen router, providing latest hardware for VoIP, WIFI, IPTV and other media services, can be connected to the XON1300 to enable the Home Network (LAN) with a ultra high speed Internet access supporting Multigigabit with up to 2.5 Gbps.

## RF Video Overlay: Multiple Options for TV-Services

All CPEs from BKtel are prepared for RF Video Overlay. The subscriber is not restricted to receive TV services in analog PAL or NTSC on his TV set but - by simply using common Set Top Boxes - also digital TV is available. The kind of signals transmitted by the RF Video Overlay can come from a whole range of different sources. The classical approach is the transmission of cable television (CATV) consisting of analog and digital cable TV (DVB-C, DVB-C2). But also terrestrial digital TV (DVB-T, DVB-T2) and satellite TV (DVB-S, DVB-S2) can be provided. Moreover digital terrestrial or cable TV in combi-

nation with satellite TV services can be offered simultaneously even as an Open Access video system with two different video service providers. The output signals of RF Video Overlay solutions are inherently compatible with standard TV or today's HD TV sets, assuming that it is equipped with an appropriate tuner or uses an external Set Top Box. The attached table shows the enormous DVB data rate capacity of the different RF Video Overlay options: The RF Video Overlay system offers between 3 and 7 Gbps capacity of video broadcast transmission equal to hundreds of TV programs.

### Table of Contents

	Page
FTTH Network Architectures.....	4
Customer Premises Equipment.....	6
RF Video Overlay .....	7
- Optical Transmitters.....	7
- Optical Amplifiers .....	8
- Optical Splitters .....	11
Network Management .....	13
Provisioning of Network Termination Units.....	14
Our Company .....	15



RF video Overlay solution	No. of AM TV channels (PAL, NTSC)	No. of QAM256 channels (DVB-C)	No. of QAM64 channels (DVB-T)	No. of 8-PSK channels (DVB-S)	DVB total data rate (Gbps)
CATV	35	59	-	-	3,04
DVB-C	-	94	-	-	4,85
DVB-T	-	-	94	-	2,98
CATV+ 1xDVB-S(2)	35	59	-	25	5,54
DVB-C+ 1xDVB-S(2)	-	94	-	25	7,35
DVB-T+ 1xDVB-S(2)	-	-	94	25	5,48
1xDVB-S(2)	-	-	-	25	2,50

**Notes:**  
 CATV: average number of TV channels  
 AM-TV: Transmission usually with 36 FM radio channels  
 DVB-T: QAM64 and 31.688 Mbit/s in 8 MHz and 7/8 FEC rate  
 DVB-C: QAM256 with 6.8 MSym/s and 188/204 FEC rate  
 DVB-S(2): L-band 950...2200 MHz with 8-PSK and 36 MSym/s, 9/10 BCH-LDPC and 188/204 RS FEC 188/204 FEC rate

### Off-load the IP traffic

The advantages for the network operator are evident. The IP traffic is not blocked by TV content reducing the complexity and the capacity needed. He can choose out of a wide variety of different business models from

traditional cable TV to simple community antenna sharing. Needless to say that there is no change for the subscribers' TV experience; it remains as simple as always.

# FTTH Network Architectures

## Optical Ethernet and RF Video Overlay: Two Broadband Connections to your Customer

Optical access networks based on point-to-point Ethernet offer a standardized environment with equipment available from several vendors. Since a well known technology is used these networks are easy to plan and manage.

Scalability is excellent and data rates can be adapted to the requirements of the individual customer, Fast Ethernet (100 Mbit/s) up to 1 Gigabit Ethernet (1 Gbps) are technically feasible.

Broadband video connectivity over optical fiber based on standards set by the cable-TV industry provides a bandwidth equivalent to several Gbps. Analog TV, digital TV (DVB-C) and even satellite TV (DVB-S + DVB-S2) .

The following figure illustrates the set up of a modern FTTH network with its key elements: The POP (the Point of Presence, which can be installed in a building or an outdoor cabinet containing active and passive equipment) and the fiber optic feeder

and drop cables. In case of point to point FTTH each subscriber has a dedicated fiber connection from the POP to his premises. At the POP service providers have access to the FTTH network in order to launch their services.

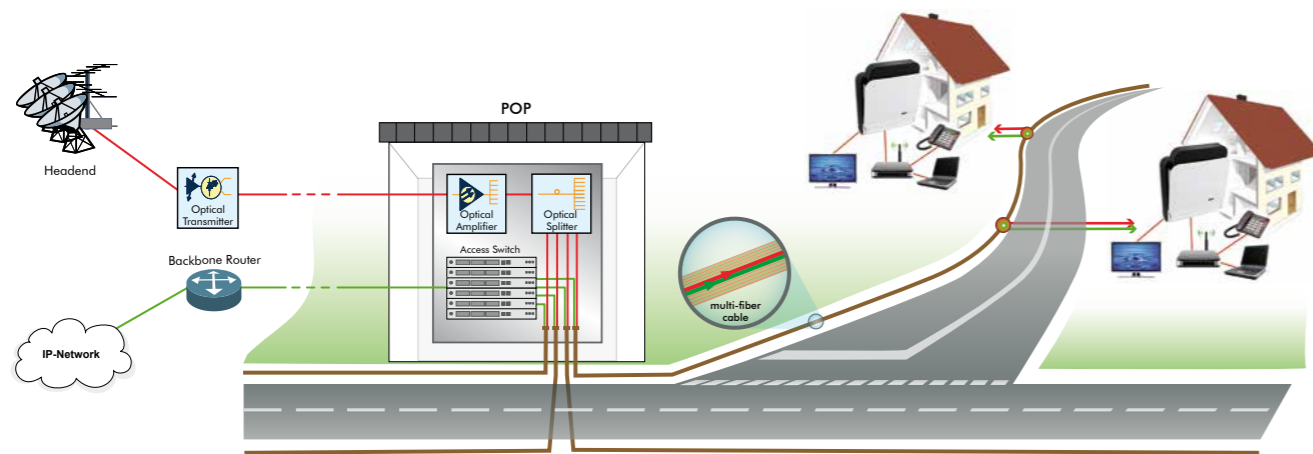

Fig. 1 and Fig. 2 display two general architectures used for point-to-point FTTH networks with RF Video Overlay. Fig. 1 shows the deployment of two separate fibers, one dedicated for data, one for the RF video. Fig. 2 shows the network based only on one fiber.

In this case the two services are multiplexed on 3 different optical wavelengths: 1550 nm for RF Video Overlay and 1490 nm/1310 nm for the bidirectional data connection.

## Ethernet Point-to-Point Topology (EPTP) Two-Fiber-Solution

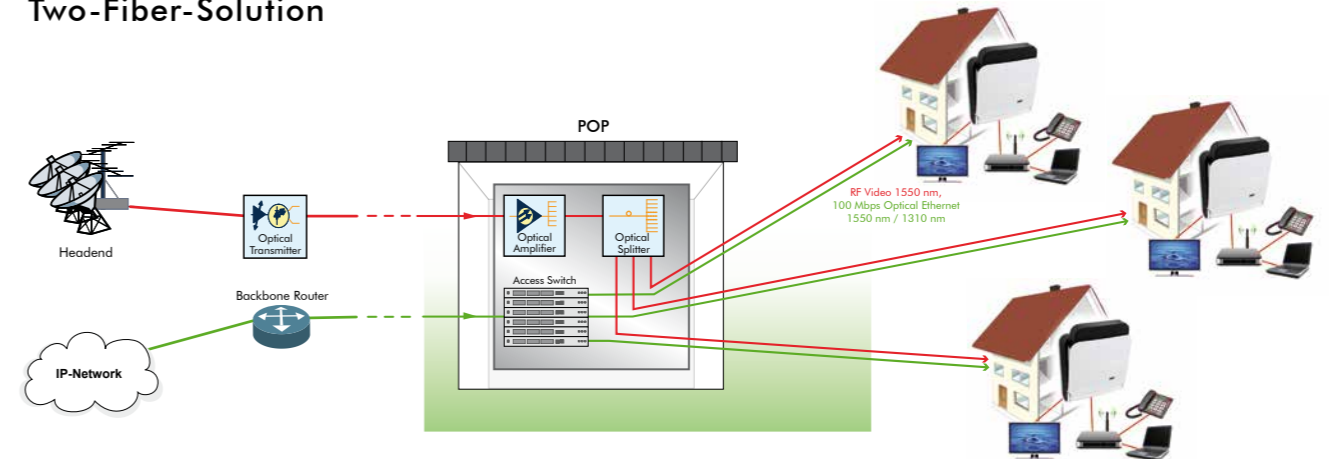

Fig. 1. The two-fiber solution for point-to-point FTTH networks: A separate fiber for data/telephony and TV-video

## Ethernet Point-to-Point Topology (EPTP) One-Fiber-Solution

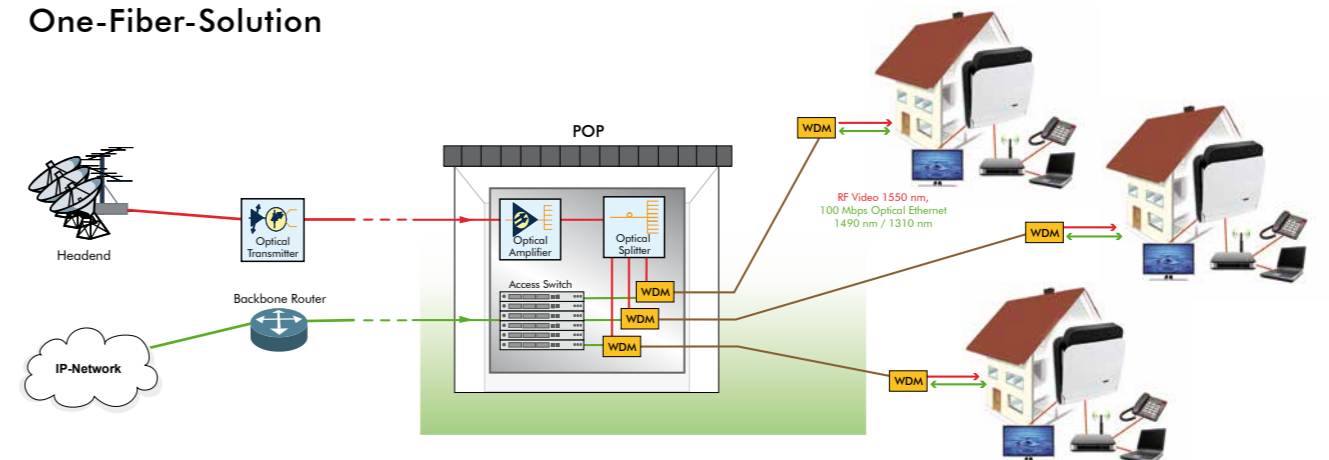
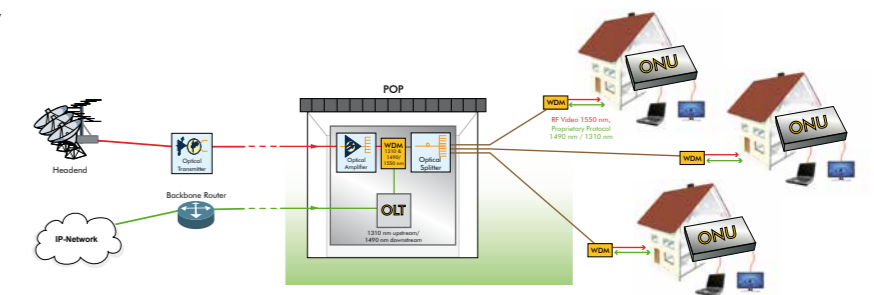

Fig.2. The one-fiber solution decreases the required fiber deployment by a factor of two, so that installation costs decrease dramatically. Port-density in the POP stays the same so that only half of the POPs are needed.

## PON and RF Video Overlay

Also point-to-multipoint FTTH networks such as GPON and GEAPON can integrate RF Video Overlay.



The RF Video Overlay can be realized in point-to-multipoint architectures such as GPON or GEAPON. BKtel offers a complete range of active equipment to support this application.

## Modern and Functional

The XON1300 are the newest members of BKtel's XON CPE family. They address the main challenges currently existing in the FTTH industry: Small footprint, low power consumption and reduced equipment and operational cost, especially in the installation and maintenance process. Acting as full managed CPE devices, the XON1300 fit to all FTTH network concepts. Including OAM, TR069 and SNMP it is possible supervise efficiently the fiber link and the status of the CPE.

## Smart System Concept: True End Customer Self Installation

The XON1300 housing allows a self installation and a self connection of the CPE by the untrained end customer. Thanks to the well-designed sliding mechanism the XON1300 can easily be inserted in the passive fiber termination unit XON30.W.

Furthermore the XON30.W offers a sophisticated fiber management, which allows a flexible usage in any cases of fiber termination or purposes of installation. With enough space for a gas blocker, optical couplers and standard splice holders, the XON30.W eases installation and fits into all FTTH application scenarios.

The installation kit XON30.WMP allows an easy upgrade of existing XON10.W fiber terminations to install the XON30.W.



## Key Features

### XON1300 Full IP managed Switch:

- ◆ TR-069 Autoprovisioning
- ◆ Multigigabit WAN interface with up to 2.5 Gbps
- ◆ 4 x 1000 Base-T LAN port
- ◆ IEEE802.1Q VLAN handing
- ◆ Quality of Service / Class of Service
- ◆ Bandwidth Control
- ◆ Remote Diagnostics via SNMP
- ◆ Ultra low nose CATV receiver with adjustable AGC

### General Technical Data

- ◆ Size: 48 x 150 x 150 mm (XON30.W)
- ◆ Weight: < 500g (XON1300.SC)
- ◆ Power Supply: 6V DC
- ◆ Power Consumption: < 4.5W (XON1300.SC)

### Available Units

- ◆ XON1300.SC (One- or Two-Fiber-Solution available)
- ◆ XON1300.S
- ◆ XON1300.C
- ◆ XON1300.C-WDM
- ◆ XON1300.P
- ◆ XON1300.P-WDM

## Optical Transmission

A key component of an RF Video Overlay system is the optical transmitter converting the electrical TV signal into an optical modulated signal. The optical wavelength is generally chosen in the range of 1550 nm because optical amplifiers with high performance are available for this wavelength.

BKtel offers a range of optical transmitters: The high end external modulated type is required for extended networks with large distance to be covered. Direct modulated transmitters are only useful for short distance and their usage is therefore restricted to small networks with local available CATV or SAT TV feeds.

## External Modulated Transmitter

- ◆ 1550 nm high performance Optical BC (broadcast) Transmitter for FTTH networks
- ◆ Bandwidth
  - ES10XL (CATV): 47 ... 1006 MHz
  - ES28XL (CATV + SAT): 47 ... 870 MHz CATV 950-2800 SAT-TV
- ◆ Long distance > 100 km
- ◆ SBS threshold adjustment
  - ES10XL (CATV): up to +19 dBm for 65 km fiber
  - ES28XL (CATV + SAT): up to +15 dBm for 40 km fiber
- ◆ Automatic Gain Control (AGC)
- ◆ Up to 2 x 13 dBm optical output power

## ES10XL / ES28XL



## Direct Modulated, Amplified Optical Transmitter

- ◆ RF Video Overlay with 1550 nm wavelength in FTTH networks providing very high optical budget (GPON compatible)
- ◆ Bandwidth 1.2 GHz
- ◆ Optical output power 8 or 16 x 21 dBm
- ◆ Up to 10 km distance
- ◆ Element Controller NECxE-E integrated
- ◆ Redundant powering

## AOTxEnnxxx



## Optical Amplification

The optical amplifier, the second key component, is required in order to recover the optical signal level after transmission over long fiber distances

(inline amplifier, EDFA) or in order to boost its level for the final distribution (YEDFA) to a large number of end users.

### Optical Amplifier (EDFA)

- ◆ Optical amplification of CATV and SAT-IF signals in FTTH networks, 1540 nm - 1560 nm
- ◆ Adjustable output power
- ◆ Constant Output Power Mode and Constant Gain Mode
- ◆ SBS detection

OVxEnxxx



### High Power Optical Amplifier (YEDFA)

- ◆ RF Video Overlay in FTTH networks, used as Booster Amplifier on the last mile
- ◆ Amplification of CATV and SAT-IF signals in FTTH networks, 1545 nm - 1565 nm
- ◆ Pre- and Booster Amplifier in one 19" device
- ◆ Usable in combination with external modulated Optical Transmitter (ES10, ES28)
- ◆ Adjustable output power
- ◆ Constant Output Power Mode and Constant Gain Mode
- ◆ Optional input redundancy switch (nominal and redundant optical input)

OVxEnxxx



OVSxEnxxx



#### Available Versions

- ◆ 16 x 17 dBm (SC/APC or LC/APC) in 1 RU\*
- ◆ 32 x 17 dBm (LC/APC) in 1 RU\*
- ◆ 16 x 21 dBm (LC/APC) in 1 RU\*
- ◆ 8 x 21 dBm (LC/APC) in 1 RU\*
- ◆ 64 x 17 dBm (LC/APC) in 2 RU\*

### High Power Optical Amplifier with integrated Optical Input Switch

- ◆ RF Video Overlay in PON systems
- ◆ Up to 64 ON-ports can be connected
- ◆ Amplification of 1550 nm optical signals on single mode fibers in FTTH Video overlay and CATV networks
- ◆ Input redundancy switch (nominal and redundant optical input)
- ◆ Cladding-pumped ErYb-doped fiber amplifier technology
- ◆ 1310&1490/1550nm WDM coupler at each output for multiplexing of bidirectional IP traffic
- ◆ Optical preamplifier (EDFA) included
- ◆ Output power up to 19.0 dBm
- ◆ 32 or 64 output ports (internal optical splitter)

OVSxEnxxx-IP



- ◆ Broad optical wavelength range (1545... 1563 nm)
- ◆ Constant output power control
- ◆ Supervision of the optical input level, optical output level and pump laser current

### Optical Amplifier for Outdoor Applications (EDFA)

- ◆ RF Video Overlay in FTTH networks, used as Booster Amplifier on the last mile
- ◆ 48 VDC redundant power supply
- ◆ Amplification of CATV and SAT-IF signals in FTTH networks, 1545 nm - 1565 nm
- ◆ Adjustable output power 13 ... 17 dBm
- ◆ Element Controller NECx-E integrated

KOAxEnxxx



#### Available Versions

- ◆ 4 x 17 dBm (LC/APC)
- ◆ 8 x 17 dBm (LC/APC)

\* RU = Rack Unit

## Optical Amplifier for Outdoor Applications (YEDFA)

KOAxEnnxxx(-IP)

- ◆ Outdoor application
- ◆ SNMP management via Ethernet
- ◆ 48 VDC redundant power supply
- ◆ LC / APC connectors
- ◆ GPON/10GPON/10GEAPON WDM at each output for multiplexing of bidirectional IP traffic available



### Available Versions:

- ◆ 32 x 17.0 dBm (-IP) (LC/APC) in 2 RU\*
- ◆ 16 x 20.0 dBm (-IP) (LC/APC) in 2 RU\*
- ◆ 8 x 20.0 dBm (LC/APC) in 1 RU\*

## Optical MDU Amplifier

XOA4145

- ◆ Optical booster amplifier for in- or intra-building extension of FTTH RF video or CATV broadcast networks
- ◆ Compact, low cost, high-performance EDFA
- ◆ 4 output ports, 14.5 dBm optical power each
- ◆ Constant Output Power Mode
- ◆ RF monitor port
- ◆ 1x SC/APC in, 4 xSC/APC out
- ◆ Solid metal housing with fiber management unit, wall mountable
- ◆ Designed for installation in multiple dwelling units (MDU)



## Passive Optical Power Splitting on an RF only System

The third key component is represented by passive optical splitters and optical wavelength division multiplexers (WDM). The components are required for splitting optical power

in order to supply adequate optical signal level to the end user or to combine or separate the different optical wavelengths on a fiber optic link.

## Optical Splitter

- ◆ RF Video Overlay in FTTH networks
- ◆ Up to 64 output ports available in 1 or 2 RU
- ◆ Optical connector: SC/APC or LC/APC
- ◆ Insertion loss < 19.7 dB
- ◆ Uniformity < 1.6 dB
- ◆ Wavelength range: 1260 -1650 nm

FOVnnn-PLC



## 16 x 1310 & 1490 & 1610 / 1550 nm WDM Array in 19" Housing

- ◆ 16 x 1310 & 1490 & 1610 / 1550 nm WDM
- ◆ 16 SC/APC RF Video In
- ◆ 16 SC/PC GPON/GEAPON In/Out
- ◆ 16 LC/APC combined RF Video + GPON/GEAPON In/Out
- ◆ Insertion loss RF Video: <1.0 dB
- ◆ Insertion loss GPON/GEAPON: <0.6 dB
- ◆ 1 RU

Also available with 8 WDMs

FWM016-OLT



\* RU = Rack Unit

## Optical Splitter + Integrated WDM Array

- ◆ IP and RF Video Overlay in FTTH networks over one fiber: 1310 & 1490 & 1610 nm IP / 1550 nm RF Video
- ◆ 1 Input port RF Video
- ◆ 1 RU

### Available Versions:

#### FOV016-PLC-IP

- ◆ 16 In/Out ports IP (MPO APC)
- ◆ 16 combined RF Video and IP In/Out ports (SC/APC)
- ◆ Insertion loss < 15 dB
- ◆ Uniformity < 1.9 dB

#### FOV032-PLC-IP

- ◆ 32 In/Out ports IP (MPO APC)
- ◆ 32 combined RF Video and IP In/Out ports (SC/APC)
- ◆ Insertion loss < 18 dB
- ◆ Uniformity < 1.9 dB

#### FOV064-PLC-IP

- ◆ 64 In/Out ports IP (MPO APC)
- ◆ 64 combined RF Video and IP In/Out ports (LC APC)
- ◆ Insertion loss < 20.7 dB
- ◆ Uniformity < 2 dB

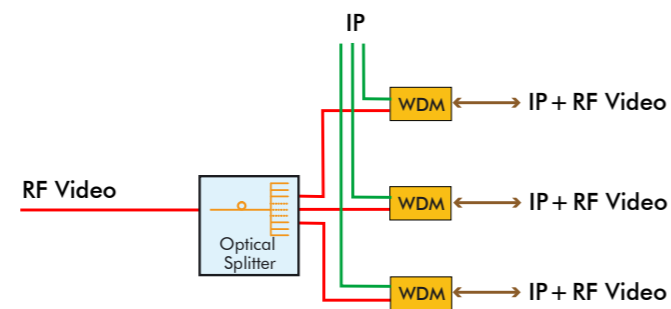

For monitoring, control and configuration of the active equipment the new Network Element Controller (NECx-E) integrated in optical transmitters or optical amplifiers is available. The NECx-E is equipped with an extended security engine for HTTPS connections from any web browser. The remote SNMPv3 interface allows controlling and monitoring of all active components and provides the interface to a higher level Umbrella Management System, such as the BKtel CABLEwatch EMS.

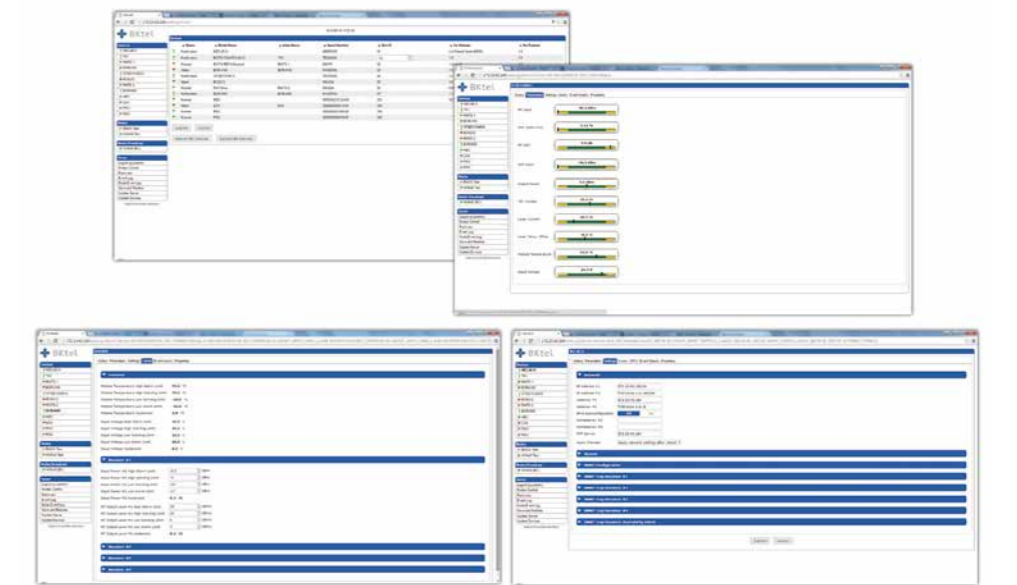
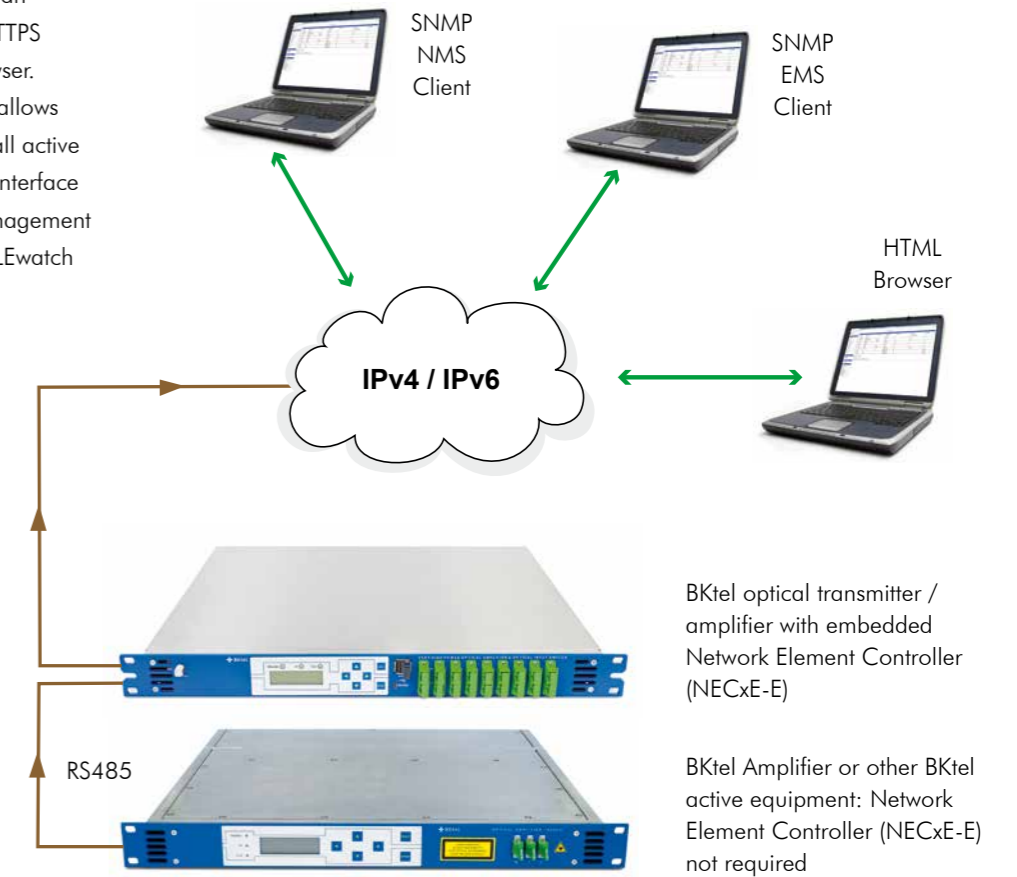

\* RU = Rack Unit

To complete a FTTH network BKtel offers the Device Auto Configuration System (DACS). DACS is a software solution that automates the remote configuration process of all CPEs in FTTH networks without any customer hardware assignment. Based on DHCP Option 82 DACS allocates the subscribed services and provides each connected CPE device with the corresponding configuration parameters. The software system is especially designed for the operation with BKtel's XON product family.

## Features

- ◆ Access port based configuration via DHCP Option 82
- ◆ Remote configuration of all parameters
- ◆ Automatic firmware management for each device type
- ◆ TFTP/DHCP management included
- ◆ Fully automated device configuration

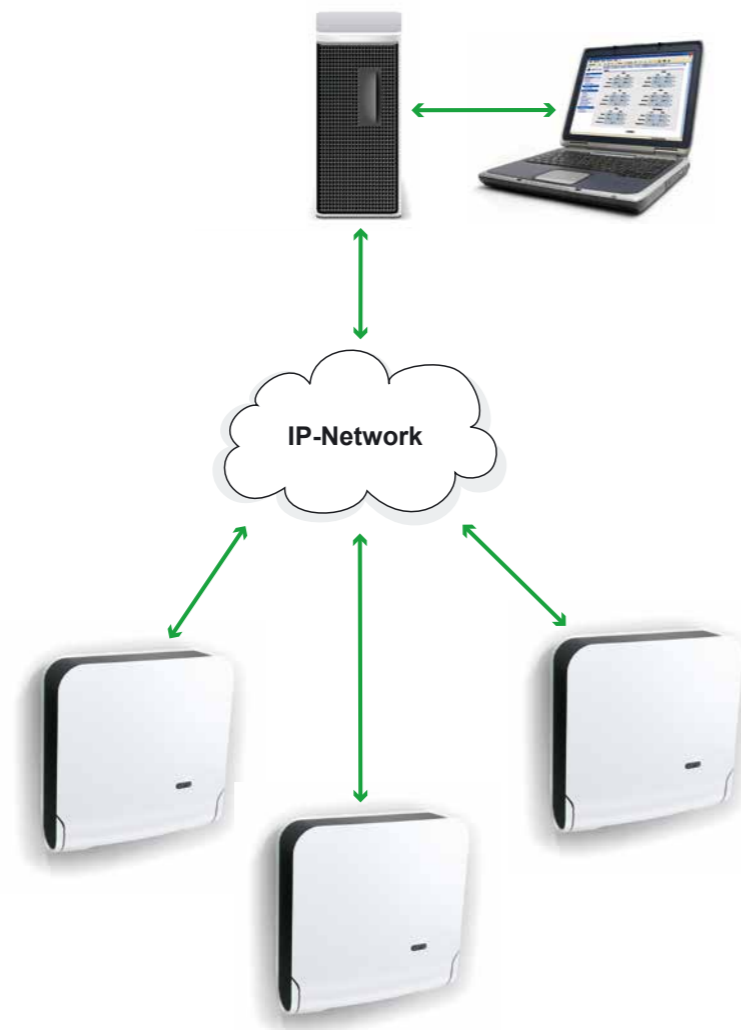

### BKtel Provisioning:

- ◆ IP address assignment (DHCP)
- ◆ Switch configuration (e.g. VLANs)
- ◆ VoIP configuration
- ◆ Firmware upgrade
- ◆ Default configuration upgrade

### Remote Diagnostics of CPE:

- ◆ Optical Transceiver parameters
- ◆ Physical Port Status
- ◆ Voice Status
- ◆ Direct Link Detection
- ◆ Optical Input Power of the CATV receiver



### Our Company

The BKtel Group has its origin in the foundation of BKtel communications in 1997. The group was extended in 2002 with BKtel systems (merged with BKtel communications in 2009), BKtel components (2006), BKtel Photonics (2014) and BKtel networks in 2017. Further international offices were founded in China and Japan for the growing Asian market. The entire group has currently a workforce of over 130 employees worldwide, based in Germany in Hueckelhoven, (near Düsseldorf), in Rosenheim (near Munich) and in Kornwestheim (near Stuttgart).

The company develops and manufactures products in the field of interactive FTTH-, Video Overlay-, RfOG- and HFC-networks for high performance data, telephone and cable TV services. The high quality products as well as the comprehensive support in designing optical networks make BKtel to one of the leading suppliers in the FTTH and HFC market.

### Our Products

BKtel develops equipment and software for FTTH and HFC broadband networks. The product portfolio includes a wide range of products starting from equipment for optical transmission such as optical transmitters, amplifiers, and receivers and customer premises equipment, CATV headends, coaxial cable amplifiers. BKtel manufacturing facilities guarantee a high quality standard (ISO 9001 certified). Furthermore the company offers a complete range of services such as planning, installation and training.





# BKtel

## **BKtel communications GmbH**

Benzstrasse 4  
41836 Hueckelhoven-Baal  
Germany  
Phone: +49 (0) 24 33 / 91 22-0  
Fax: +49 (0) 24 33 / 91 22-99

### *Office Kornwestheim:*

Bahnhofstrasse 82  
70806 Kornwestheim  
Germany  
Phone: +49 (0) 71 54 / 1 59 90-0  
Fax: +49 (0) 71 54 / 1 59 90-77

## **BKtel networks GmbH**

Mangfallstrasse 37  
83026 Rosenheim  
Germany  
Phone: +49 (0) 80 31 / 7 96 75-0  
Fax: +49 (0) 80 31 / 7 96 75-99

Internet: [www.bktele.com](http://www.bktele.com)  
Email: [info@bktele.com](mailto:info@bktele.com)

## **Representations:**

BKtel Pacific Rim (Japan) Inc.  
Katsukou Building 5F  
1-2-8, Hourai-cho, Naka-ku,  
Yokohama, Kanagawa 231-0048, Japan  
Phone: +81 45 350 5447  
Fax: +81 45 350 5460

## **BKtel Latam**

Oficina de Representación  
Pedro Torres n.º 231, planta 302  
Municipalidad de Ñuñoa  
Santiago, Chile  
Phone: +56 220 468 46  
Email: [berriozabal@bktele.com](mailto:berriozabal@bktele.com)

## **BKtel local representatives:**

France:  
André Balva  
[balva@bktele.com](mailto:balva@bktele.com)

South East Asia:  
Roland Wuerth  
[wuerth@bktele.com](mailto:wuerth@bktele.com)

